

Part Number: PT296-00170
PT296-12170
 (Extension Module w/ AHA)

Kit Contents

Item #	Quantity Req'd.	Description
1	1	Extension Module
2	1	BT cable
3	1	DA/Ext Harness
4	1	GPS Antenna kit
5	6	Bolt (M5x8)
6	5	Wire tie (10")

Hardware Bag Contents

Item #	Quantity Req'd.	Description
1	1	GPS Antenna
2	1	GPS Plate w/ Adhesive
3	5	Wire tie (6")
4	1	Foam pad w/ Adhesive

Additional Items Required For Installation

Item #	Quantity Req'd.	Description

Conflicts

Interior light kit

Recommended Tools

Personal & Vehicle Protection	Notes
Blankets	
Special Tools	Notes
USB Flash Drive Media	Must contain MP3 songs
AUX tester	
Installation Tools	Notes
Panel Clip Removal Tool	e.g. Toyota SST P/N: 00002-06002-01
Ratchet	
Socket	8mm, 10mm
Socket Extension	6"
Screwdriver	Phillips, #2
Torque Wrench	5.4N·m (48 lbf·in)
Scissors	
Masking tape	
Electrical Tape	
Pliers	Needle Nose
Diagonal Cutters	
Special Chemicals	Notes
Cleaner	

General Applicability

All iM models

Recommended Sequence of Application







Item #	Accessory
1	Navigation Upgrade (Extension Module)
2	Base Audio
3	

*Mandatory

Vehicle Service Parts (may be required for reassembly)

Item #	Quantity Req'd.	Description
1		
2		
3		

Legend

	STOP: Damage to the vehicle may occur. Do not proceed until process has been complied with.
	OPERATOR SAFETY: Use caution to avoid risk of injury.
	CAUTION: A process that must be carefully observed in order to reduce the risk of damage to the accessory/vehicle and to ensure a quality installation.
	TOOLS & EQUIPMENT: Used in Figures calls out the specific tools and equipment recommended for this process.
	REVISION MARK: This mark highlights a change in installation with respect to previous issue.
	SAFETY TORQUE: This mark indicates that torque is related to safety.

Parts Description of Extension Module Kit (PT296-00170 or PT296-12170)

Item #	Part Name	Part No.	Qty
1	Extension Module	PT296-00170-AA or PT296-12170-AA	1
2	Harness	86842-12010	1
3	Bolt (M5 x 8)	90153-W0001	6
4	BT cable	86705-02070	1
5	GPS Antenna	PZ490-00338-00	1
6	Wire Tie (10")		5
7	Wire Tie (6")		5
8	GPS Plate w/ Adhesive back		1
9	Foam Adhesive Pad (25cm x 8cm)		1

Not included in kit but REQUIRED for installation: Base Display Radio (PT546-00170 or PT546-12170)

Item #	Part Name	Part No.	Qty
1	Base Display Radio	PT546-00170 or PT546-12170	1
2	Bolt (M5x8)	Included with Base Display Radio	8

Care must be taken when installing this accessory to ensure damage does not occur to the vehicle. The installation of this accessory should follow approved guidelines to ensure a quality installation.

These guidelines can be found in the "Accessory Installation Practices" document.

This document covers such items as:-

- Vehicle Protection (use of covers and blankets, cleaning chemicals, etc.).
- Safety (eye protection, rechecking torque procedure, etc.).
- Vehicle Disassembly/Reassembly (panel removal, part storage, etc.).
- Electrical Component Disassembly/Reassembly (battery disconnection, connector removal, etc.).

Please see your Toyota dealer for a copy of this document.

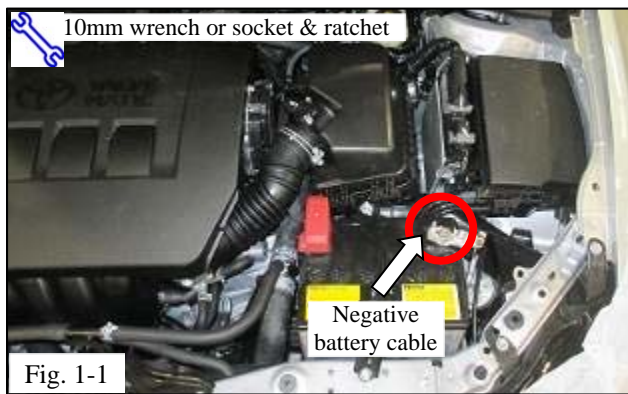

1. Protect the Vehicle.

- (a) Protect the fender before starting.
- (b) Remove the negative battery cable (Fig. 1-1).
- CAUTION:** Do not touch the positive terminal with any tool when removing cable.
- (c) Check the kit contents.
- (d) Cover the steering wheel with a blanket to prevent scratches.

2. Disassemble the Vehicle.

- NOTE:** Place all removed parts on a protected surface.
- NOTE:** When disconnecting wiring connectors DO NOT pull on the wiring, pull on the connector only.
- NOTE:** Engage the parking brake while working.

- (a) Remove the driver side lower finish instrument panel (Fig. 2-1).



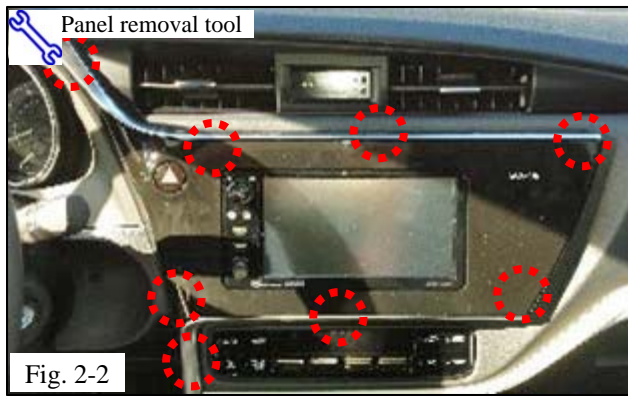

- (b) Remove the audio trim panel (Fig. 2-2).
 - (1) Detach the first clip at right top corner of the panel.
 - (2) Detach the remaining clips along the top of the panel.

⚠ CAUTION: Since the top-left corner is extended from the main body of the trim panel, use special care so as not to damage it.

- (3) Detach the center and bottom clips.

⚠ (4) Disconnect the two connectors connected to the back of the trim panel (Fig. 2-3).

- (5) Slide the tab at the bottom left corner of the panel outward to the left and remove the panel.

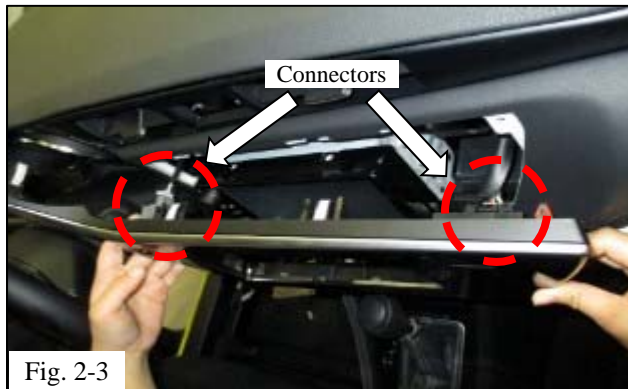

- (c) Remove the center instrument panel (Fig. 2-4).

⚠ NOTE: Do not remove the heater control unit that is attached to the center instrument panel.

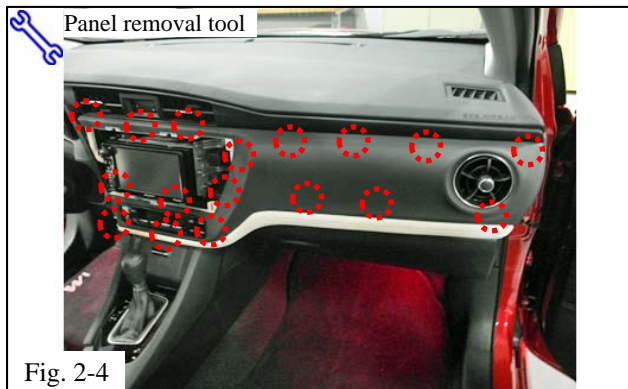

- (d) Remove the base display radio (Fig. 2-5).

⚠ (1) Remove and save the four (4) bolts.

- (2) Pull the base display radio out and disconnect all connectors connected to the back of the radio.

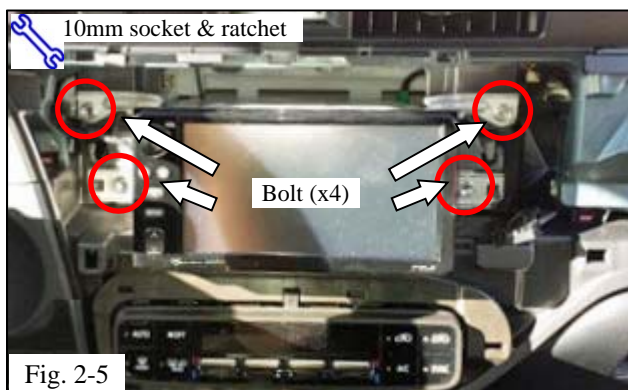

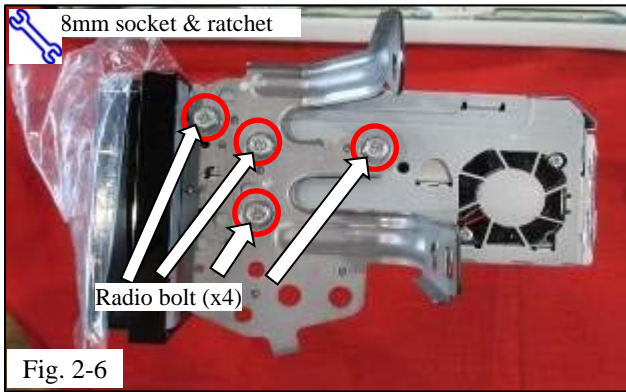

(e) Remove the four (4) (M5x8) bolts from the RH bracket on the base display radio and remove the RH bracket (Fig. 2-6).

(1) Save the bracket and bolts.

 (2) The LH bracket does not need to be removed.

3. Install the GPS Antenna.

(a) Install the GPS plate.

 (1) Clean the GPS antenna mounting surface with household cleaner.

(2) Locate the flat surface on the upper left of the plastic molding in the audio opening area (Fig. 3-1 & Fig. 3-2).

(3) Remove the release paper from the GPS plate.

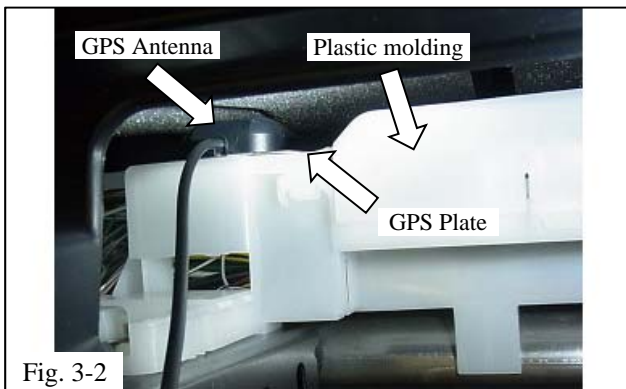
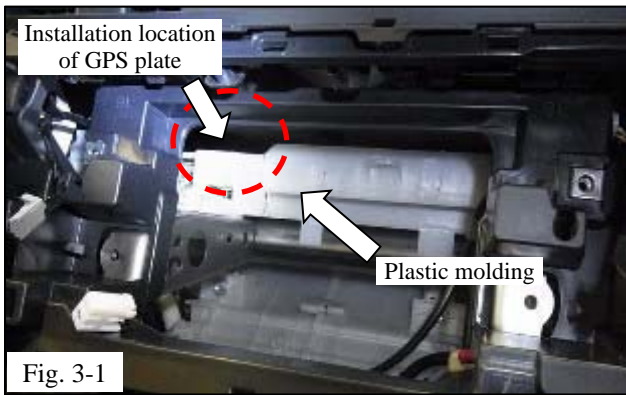

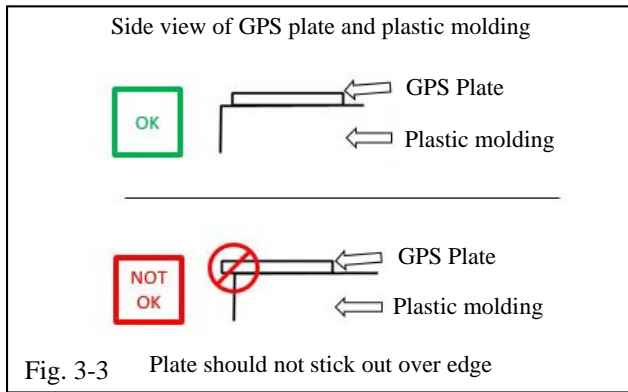

(4) Attach the GPS plate to the plastic molding (Fig. 3-1 through Fig. 3-3).

STOP NOTE: Ensure the GPS plate sits entirely on the plastic molding. The plate **SHOULD NOT** stick out over the front or side edges (Fig. 3-3).

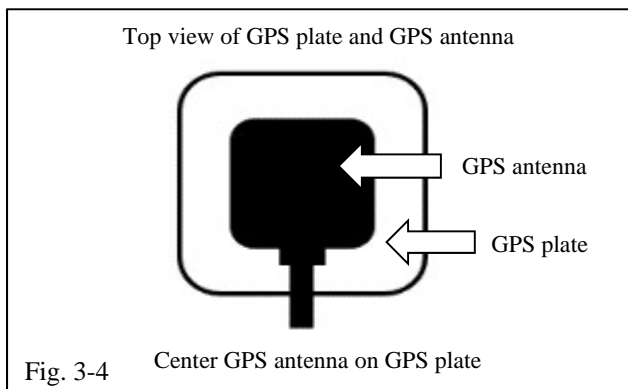

(b) Install the GPS antenna and harness.

(1) Place the GPS antenna onto the center of the GPS plate (Fig. 3-2 & Fig. 3-4).

STOP NOTE: Ensure the GPS antenna is centered on the GPS plate (Fig. 3-4).

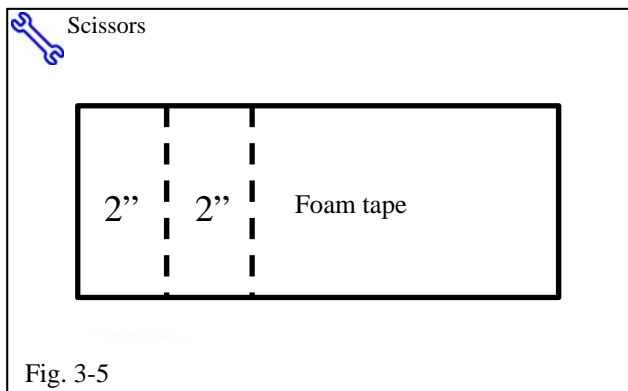

(2) Cut off two 2-inch (about 50mm) pieces of foam tape from the tape included in the kit (Fig. 3-5).



(3) Apply one piece of foam tape over the GPS antenna and attach it to the GPS plate and plastic molding to prevent the antenna from moving (Fig. 3-6).

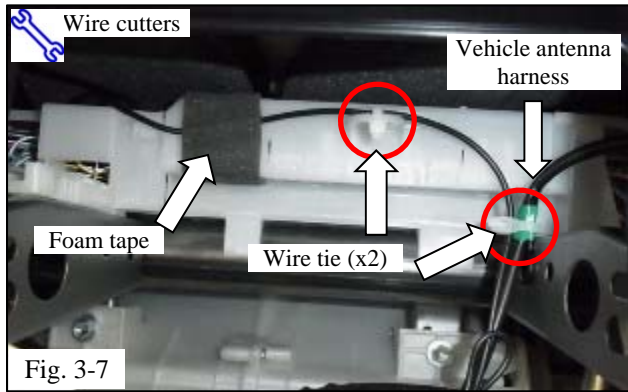

(4) Route the GPS harness along the plastic molding to the right and secure it to the plastic molding and the vehicle antenna harness with two 10" wire ties (Fig. 3-7).

⚠ NOTE: A little bit of slack should exist between the GPS antenna and the first wire tie to prevent the GPS antenna from being pulled out of place during installation.

(5) Apply a piece of foam tape to the harness and plastic molding between the GPS antenna and the first wire tie to prevent rattling (Fig. 3-7).

(6) Continue to route the GPS harness along the vehicle antenna cable toward the antenna connector. Align the GPS connector with the vehicle antenna connector (Fig. 3-8).

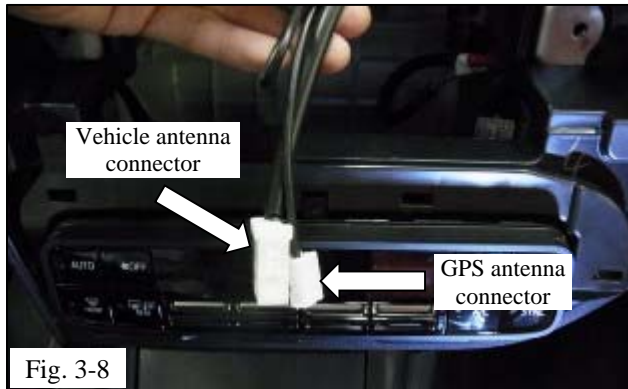

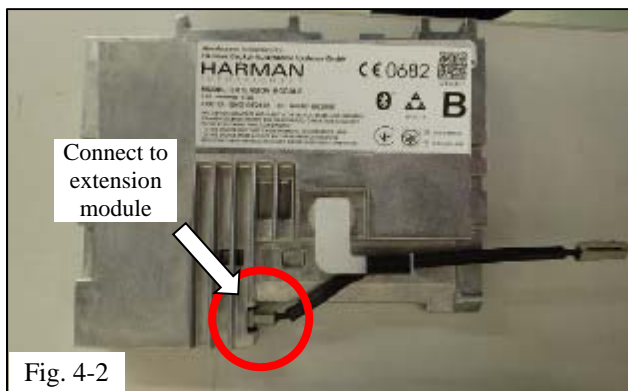
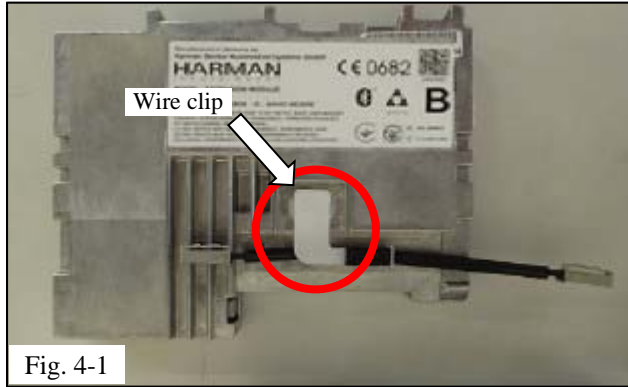
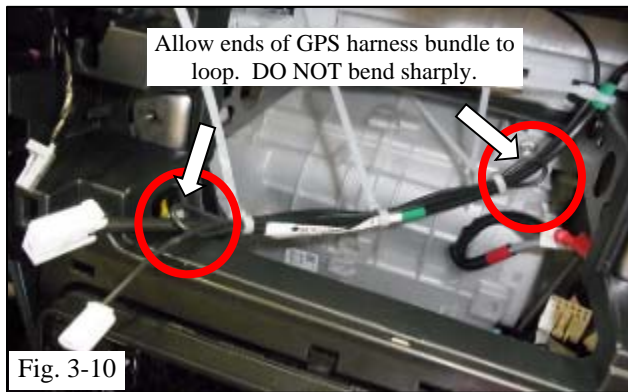
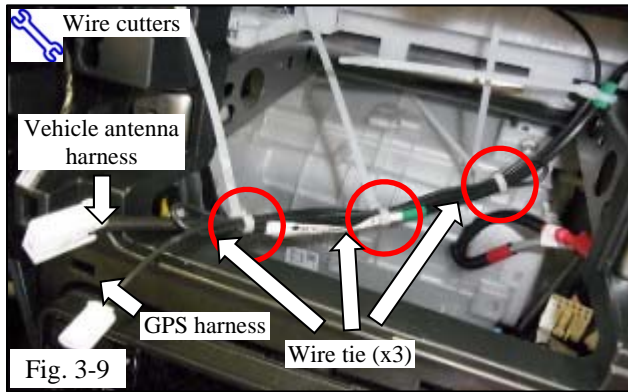

(7) While keeping the GPS connector lined up to the vehicle antenna connector, bundle any excess wire and secure the excess to the vehicle antenna harness with three 10" wire ties (Fig. 3-9).

⚠ NOTE: Leave a loop at each of the bundled ends. Avoid bending the GPS antenna cord sharply at the ends marked with red circle (Fig. 3-10).

(8) Trim all wire ties.

4. Assemble the Radio and Extension Module.

- (a) Lay the extension module on a flat surface with the large label side facing upwards (Fig. 4-1).
- (b) Insert the wire clip that is attached to the Bluetooth antenna wire into the extension module (Fig. 4-1).
- (c) Plug the Bluetooth antenna connector into the extension module (Fig. 4-2).
- (d) Lay the radio on a flat surface with the bottom facing upward.

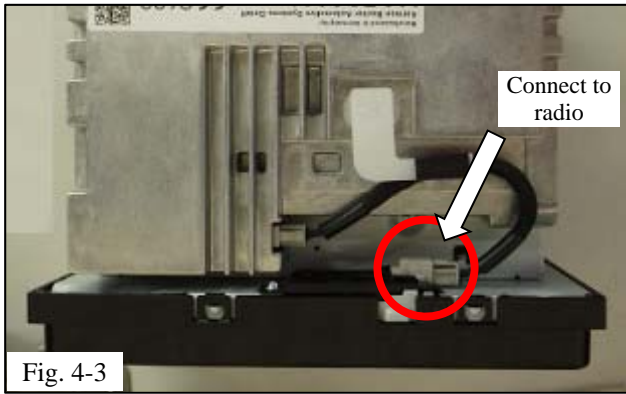

- (e) Place the extension module on the bottom of the radio (Fig. 4-3).
- (f) Plug the Bluetooth antenna connector into the radio (Fig. 4-3).

⚠ NOTE: Make sure both ends of the harness are securely seated between the extension module and the radio.

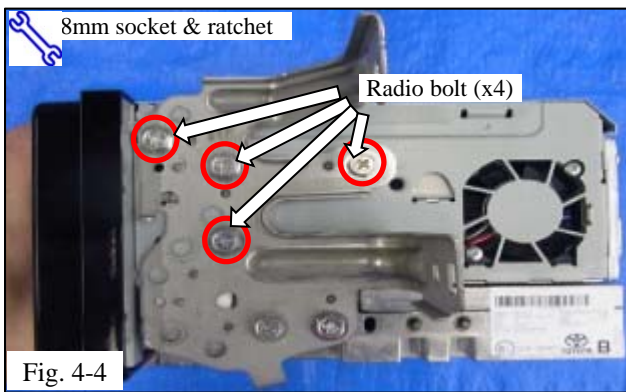

- (g) Install the RH mounting bracket to the audio unit and the extension module.
- (h) Fasten the RH mounting bracket to the audio unit using the four (4) audio bolts removed in Step 2(e) (Fig. 4-4).

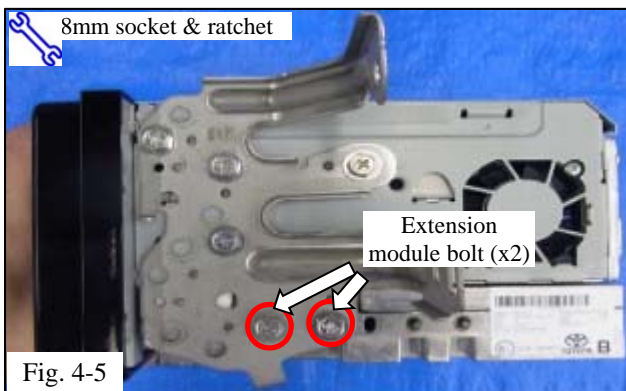

- (i) Fasten the extension box to the RH bracket with two bolts included in the extension module kit (Fig. 4-5).

⚠ NOTE: DO NOT completely tighten the bolts.

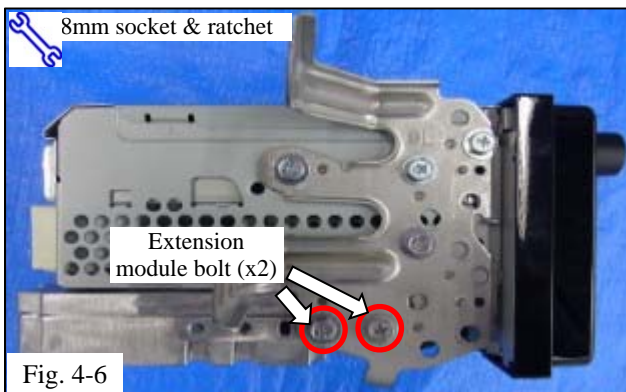

- (j) Fasten the LH mounting bracket to the extension module with two bolts from the extension module kit (Fig. 4-6).

⚠ NOTE: DO NOT completely tighten the bolts.

- (k) Align the extension module to the radio and tighten all bolts on both sides of the radio and extension module.

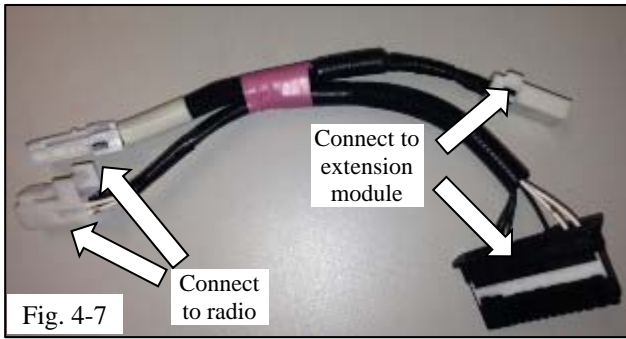

- (1) Connect the extension module interface wire harness between the extension module and the radio (Fig. 4-7 & Fig. 4-8).

5. Install the Audio/Navigation Assembly (Wire Harness Connections).

- ⚠** (a) Place a blanket around the instrument panel opening to prevent scratches (Fig. 5-1).

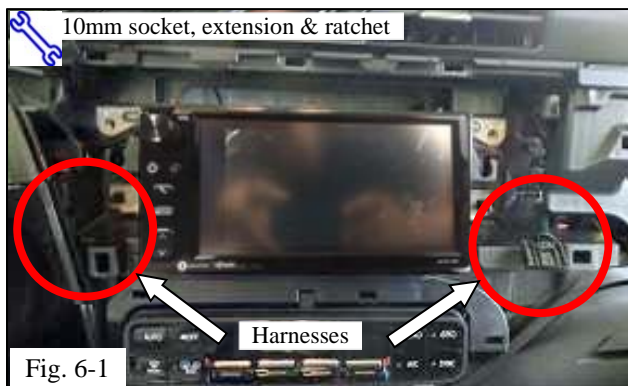
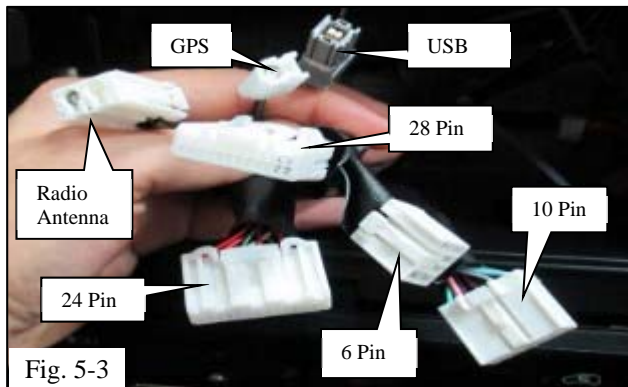
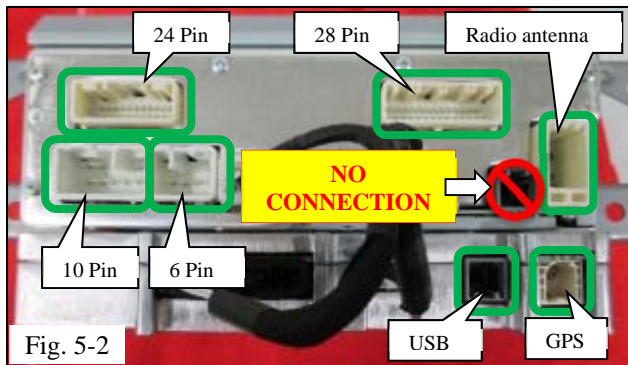

- (b) Connect the radio antenna cable, 28 pin, 24 pin, 6 pin, and 10 pin harness connector cables to the base display radio (Fig. 5-2 & Fig. 5-3).
- (c) Connect the USB cable and GPS antenna cable to the extension module (Fig. 5-2 & Fig. 5-3).



Do not connect the USB cable to the Base Display Radio. The USB cable must be connected to the extension module (Fig. 5-2).

- (d) Confirm all harness connections are completed (Fig. 5-4).

6. Install the Audio/Navigation Assembly (Mount in the Vehicle).

- (a) Install the audio/navigation assembly into the instrument panel (Fig. 6-1).



CAUTION: Ensure the two wire harnesses that connect to the audio trim panel are not trapped behind the audio unit or brackets.

- (1) Insert and hand start each bolt.



NOTE: The bolts can easily become stripped if they are started with a drill or driver tool.

- (2) Tighten the bolts.

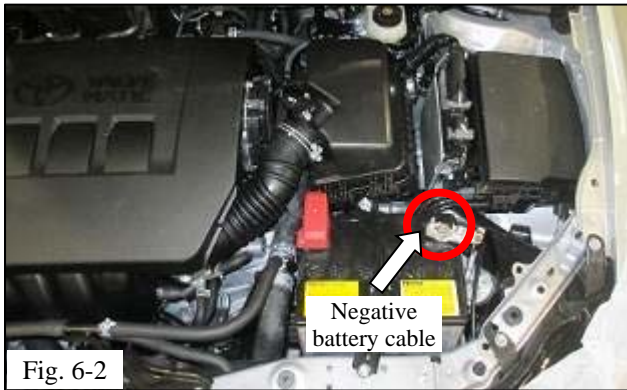

Fig. 6-2

(b) Temporarily connect the negative battery cable (Fig. 6-2).

+ **CAUTION:** Do not touch the positive terminal with any tool when attaching the cable.

7. Confirm that the Extension Module is Connected.

(a) Turn the vehicle ignition switch to the ACC position.

(b) After the warning screen, press the "MEDIA" button.

! **NOTE:** Each time the "MEDIA" button is pressed the system will switch the screen between MAP and the last audio mode used (Fig. 7-1).



Fig. 7-1

(c) Confirm if the Map screen is shown (Fig. 7-1).



8. Check the USB & AUX Connections.

- (a) With the ignition switch still the in ACC or position, connect the USB flash drive media to the vehicle’s USB connector (Fig. 8-1).
- (b) Press the “MEDIA” source button to see the map split view screen. The audio source split view should show the USB audio playback (Fig. 8-2).
- (c) Confirm that the USB source can be selected.
- (d) Confirm that a song plays.
- (e) Remove the flash drive from the USB jack.
- (f) Press the “MEDIA” button.
- (g) Press the source button to go to the audio screen.
- (h) Plug in the AUX tester.
- (i) Confirm that the AUX source can be selected.
- (j) Remove the AUX tester.

9. Check the Microphone and Vehicle Antenna.



- (a) With the ignition switch still the in ACC position, press the  button (Fig. 9-1).
- (b) After the beep say, “Tune to 99.7.”
- (c) Wait until the voice recognition session is complete. The screen should switch to FM mode showing FM 99.7.



Fig. 9-2

- (d) Press the SEEK/TRACK “up” button (Fig. 9-2).
- (e) Confirm that the radio tunes to an FM radio station and sound is heard.

10. Check the Back Up Camera.

- (a) Turn the vehicle ignition switch to the ON position.
- (b) Press the brake pedal.
- (c) Shift the gear selector to REVERSE.
- (d) The back up camera image should appear on the screen (Fig. 10-1).
- (e) Shift the gear selector to PARK (or 1st gear for a manual transmission vehicle).
- (f) Turn the ignition switch to the OFF position.
- (g) Disconnect the battery negative cable.



Fig. 10-1

+ CAUTION: Do not touch the positive terminal with any tool when attaching the cable.

11. Complete the Installation.

- (a) Reinstall the center instrument panel (Fig. 11-1).

! NOTE: Ensure the two wire harnesses that connect to the audio trim panel are not trapped behind the instrument panel.



Fig. 11-1

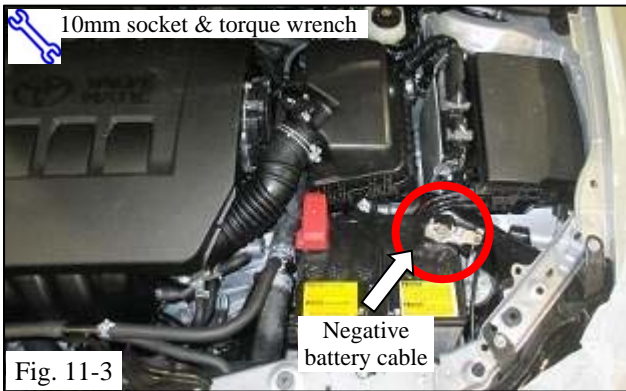

(b) Reinstall the audio trim panel to the center instrument panel (Fig. 11-2).



- (1) Reinstall the lower left panel tab by sliding it into place.
- (2) Reconnect the disconnected connectors.
- (3) Align the trim panel to the center Instrument Panel and engage the clips.

(c) Reinstall the driver side lower finish instrument panel.

(d) Reconnect the vehicle's negative battery cable (Fig. 11-3).

- (1) Position the negative cable at the original factory position.



CAUTION: Do not touch the positive terminal with any tool when replacing the cable.

- (2) Tighten the nut to 5.4 N•m (48 lbf•in).



Torque: 5.4 N•m. (48 lbf•in)

(e) Perform the functional checks.



Fig. 11-4

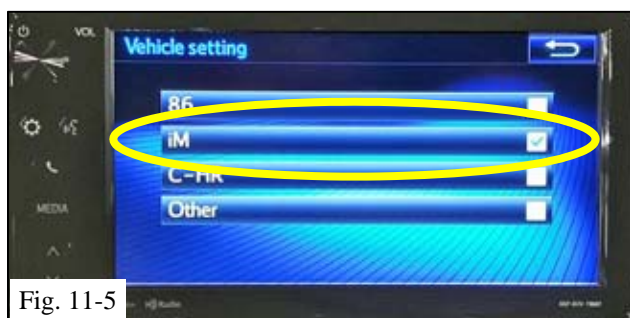



Fig. 11-5

(f) With the ignition switch in the ACC or ON position, set the vehicle specific audio configuration.

(1) Press the  button (Fig. 11-4).

(2) Select the "Vehicle" tile in the Setup menu.

(3) Select "iM" from the "Vehicle setting" list (Fig. 11-5).

(g) Turn the vehicle off.

(h) Clean up and remove any trash.

TOYOTA **iM** **2017 -** **NAVIGATION UPGRADE**
 Checklist - these points **MUST** be checked to ensure a quality installation.

<u>Check:</u>	<u>Look For:</u>
<p><u>Accessory Function Checks</u></p> <ul style="list-style-type: none"> <input type="checkbox"/> Turn on radio <input type="checkbox"/> Antenna <input type="checkbox"/> Fader <input type="checkbox"/> Balance <input type="checkbox"/> Illumination 	<ul style="list-style-type: none"> Radio functions properly Reception of AM/FM stations Functioning shift from front/rear speakers Functioning shift from left/right speakers Lights function properly
<p><u>Vehicle Function Checks</u></p> <ul style="list-style-type: none"> <input type="checkbox"/> Hazard switch <input type="checkbox"/> Steering wheel audio controls <input type="checkbox"/> Clock <input type="checkbox"/> Passenger side airbag light <input type="checkbox"/> Rheostat/Dimmer <input type="checkbox"/> Back up camera 	<ul style="list-style-type: none"> Switch functions properly Controls function properly Clock functions properly Airbag light functions properly Lights dim/brighten properly Camera/image function properly
<p><u>Vehicle Appearance Check</u></p> <ul style="list-style-type: none"> <input type="checkbox"/> After accessory installation and removal of protective cover(s), perform a visual inspection. 	<p>Ensure no damage (including scuffs and scratches) was caused during the installation process. (For PPO installations, refer to TMS Accessory Quality Shipping Standard.)</p> <p>Panels should fit & align properly</p>